

Lemi[®]
ITALIAN WELLNESS EQUIPMENT



RELAX

The RELAX line includes a series of ergonomic wooden chaise longues that ensure the "relax" position. It is an optimal position that guarantees proper blood circulation.

La linea RELAX include una serie di chaise longue in legno ergonomiche che garantiscono la posizione "relax". Si tratta di una posizione ottimale che favorisce la corretta circolazione sanguigna.

RELAX

RELAX SUITE

RELAX SUITE

UPGRADE



COD. 1246

Featuring luxury finishing and an electric adjustment of the back and legrest by handset control. Equipped with customisable base and padding.

IDEAL FOR: post-treatment relaxation.

Finiture pregiate e regolazione elettrica di schienale e gamba tramite una pratica pulsantiera. Completa di base e imbottitura personalizzabili.

IDEALE PER: relax post trattamento.

Focus on

- 2 electric motors for backrest and seat adjustment
- Fire retardant, "Azo" free, antibacterial and antifungal mattress covering
- Padded shelf included
- Practical hand set control
- 2 motori elettrici per regolazione di schienale e gamba
- Rivestimento ignifugo, "Azo" free, antibatterico, antimicotico
- Tavolino imbottito incluso
- Pratica pulsantiera

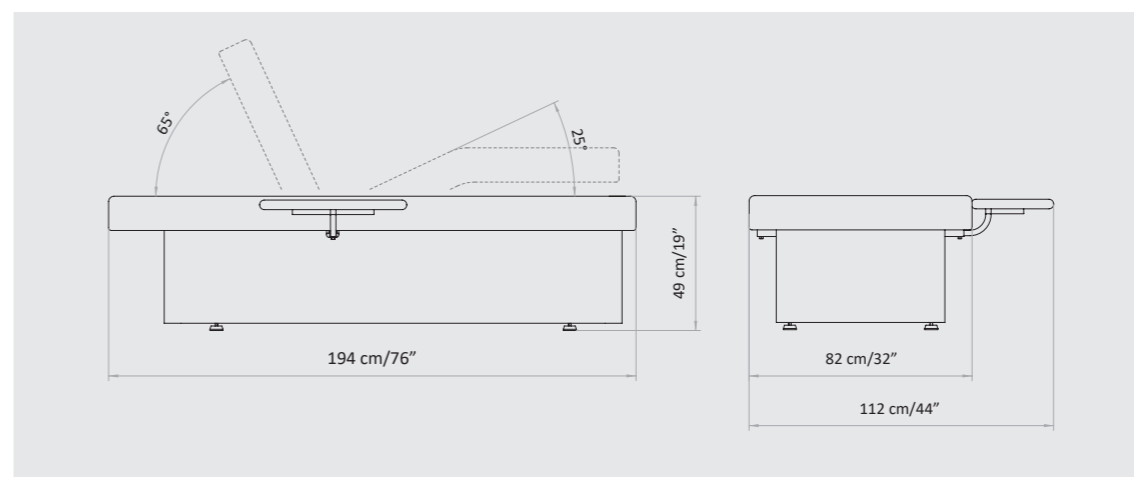

Packaging details

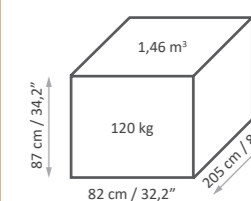

MAXIMUM CAPACITY
PORTATA MASSIMA
200 kg

MATTRESS CUSTOMIZATION

The innovative Spa Prestige and Nefos materials - which are exclusive for LEMI products - and their special finishing touch guarantee easy-cleaning and hygiene. Their extraordinary structural qualities will persist through the years. An incredibly elastic texture enhances the memory foam mattress softness and quality at its best, giving Spa Clients a complete and satisfying wellness experience.

PERSONALIZZAZIONE MATERASSO

Gli innovativi materiali Spa Prestige e Nefos - che sono un'esclusiva dei prodotti LEMI - ed il loro speciale tocco di finitura garantiscono una facile pulizia e igiene. Le loro straordinarie qualità strutturali permangono nel corso degli anni. Una texture incredibilmente elastica migliora al massimo la morbidezza e la qualità del materasso in Memory Foam, dando ai clienti Spa un'esperienza di benessere completa e soddisfacente.

SPA PRESTIGE COLORS

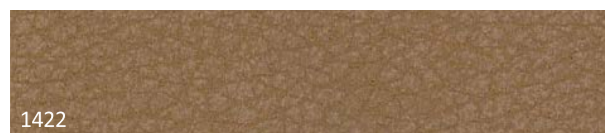
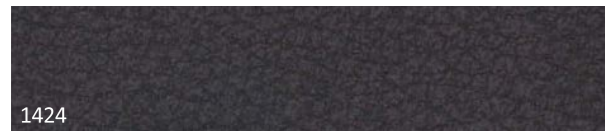

COLORI SPA PRESTIGE

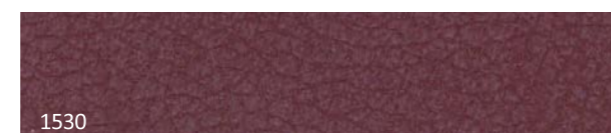
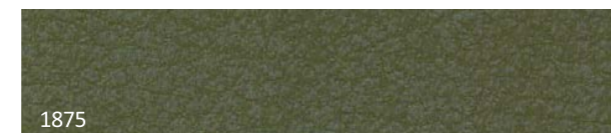
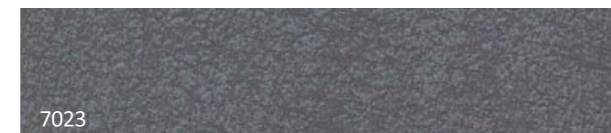
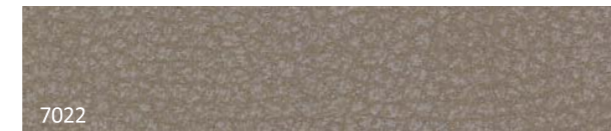

NEFOS COLORS

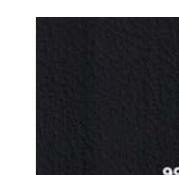
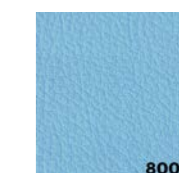
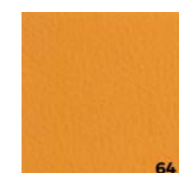
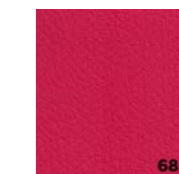
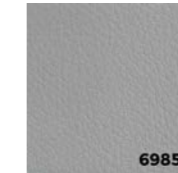
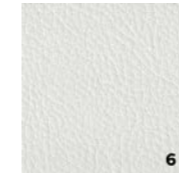

COLORI NEFOS

The images are for illustrative purposes only and may not reflect the actual finish of the product, particularly when viewed through a screen. Therefore, the **SELECTION OF THE FINISHES** of the bases and mattress **FABRICS** must take place **AFTER CONSULTING** the **LUXURY BOX PHYSICAL SAMPLES** and the NEFOS and SPA PRESTIGE **COLOR CHART**.

Le immagini hanno valore puramente illustrativo e possono non rispecchiare la finitura reale del prodotto, in particolare se visualizzate attraverso uno schermo. Pertanto la **SELEZIONE DELLE FINITURE** delle **BASI** e dei **RIVESTIMENTI** dei materassi deve avvenire **PREVIA CONSULTAZIONE** della **CAMPIONATURA FISICA** della **LUXURY BOX** e delle **CARTELLE COLORI** NEFOS e SPA PRESTIGE.

BASE CUSTOMIZATION

Relax Suite is presented with an elegant wood/metal base: the central section made with FSC certified timber from unprotected forests, while the lateral section provides a metal finish, a choice between two delicate shades such as rose and gold.

PERSONALIZZAZIONE BASE

Relax Suite si presenta con una elegante base in legno/metallo: la sezione centrale realizzata con legname certificato FSC proveniente da foreste non protette, mentre la sezione laterale prevede una finitura in metallo, a scelta tra due delicate tonalità come rosa e oro.

ACCESSORIES UPON REQUEST ACCESSORI SU RICHIESTA

All Relax tables have a standard setting customizable upon request.

Tutti i lettini Relax hanno una configurazione standard personalizzabile su richiesta.

Available finishing for RELAX SUITE Finiture disponibili per RELAX SUITE



T004 - Antracite	T002 - Nocciola	MA01 - Paradise	MA05 - Lagoon	4208 - Rovere Axe	4397 - Teak
4565 - Olmo Miele	E004 - Rovere Moro	S204 - Wengé	U002 - Urban Concrete	3096 - Bianco	U79 - Nero

Available metal finishing for RELAX SUITE Finiture metallo disponibili per RELAX SUITE

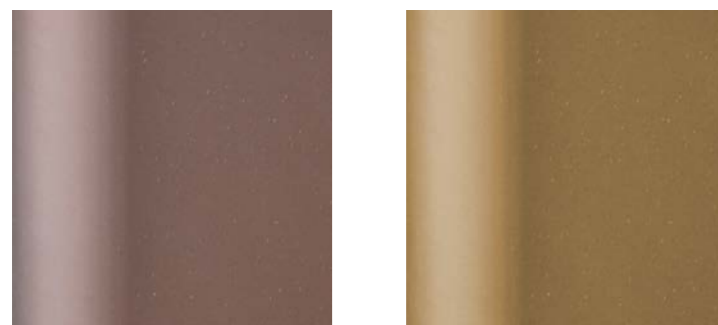

Rose	Gold
Rosa	Oro

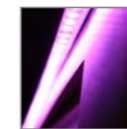

Color therapy
Cromoterapia



Heating system
Riscaldamento



Bluetooth sound system
Sistema Bluetooth

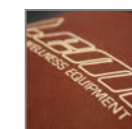

Customization with logo
Personalizzazione con logo

Le immagini hanno valore puramente illustrativo e possono non rispecchiare la finitura reale del prodotto, in particolare se visualizzate attraverso uno schermo. Pertanto la **SELEZIONE DELLE FINITURE** delle **BASI** e dei **RIVESTIMENTI** dei materassi deve avvenire **PREVIA CONSULTAZIONE** della **CAMPIONATURA FISICA** della **LUXURY BOX** e delle **CARTELLE COLORI** NEFOS e SPA PRESTIGE.

TECHNICAL REQUIREMENTS

CARATTERISTICHE TECNICHE

ABSORPTION ASSORBIMENTO	VOLTAGE VOLTAGGIO	POWER POTENZA	FREQUENCY FREQUENZA	WARRANTY	GARANZIA
2,5 Amax (1 A)	100 Vac (240Vac)	250W	50/60 Hz	<i>Mattress heating: 1 year</i> <i>Electric parts and controls: 2 years</i> <i>Undeformable foam: 5 years</i> <i>Structure: 10 years</i>	Riscaldamento materasso: 1 anno Parti elettriche e comandi: 2 anni Gomma indeformabile: 5 anni Struttura: 10 anni

REGULATIONS

All Equipment is  marked

Electrical equipment and beds

Directive 2006/42/CE (Machinery Directive) and national regulations

Directive 2014/30/UE (Electromagnetic Compatibility Directive) and national regulations.

Images

The images are for illustrative purposes only and may not reflect the actual image of the product.

NORME

Tutte le attrezzature sono a marchio 

Attrezzature e lettini elettrici

Direttiva 2006/42/CE (Direttiva Macchine) e disposizioni nazionali di attuazione

Direttiva 2014/30/UE (Direttiva Compatibilità elettromagnetica) e disposizioni nazionali di attuazione.

Immagini

Le immagini hanno valore puramente illustrativo e possono non rispecchiare l'immagine reale del prodotto.

Lemi[®]
ITALIAN WELLNESS EQUIPMENT

Brusaferrì & C srl

Via Mara Maretti Soldi, 13
26011 Casalbuttano (CREMONA) ITALY
Phone +39-0374-363069 Fax +39-0374-363071
info@lemigroup.it service@lemigroup.it

www.lemigroup.it